

TME60/80

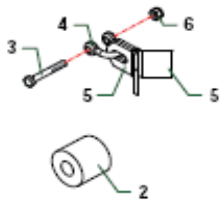

N°	Designation	Référence	Réf SCAR	TME60	TME80
2	Chappe	ME125020102		16	20
3	Boulon	O301013		16	20
4	Manille	O901118		16	20
5	Couteau	O901133	10857	32	40
6	Ecrou	O310001		16	20

TIL80/100 Monochappe

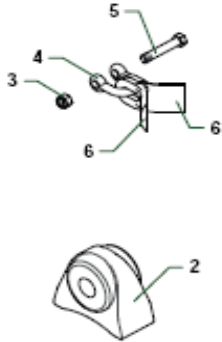

N°	Designation	Référence	Réf SCAR	TIL80	TIL100
2	Chappe	TE12020103		18	20
3	Ecrou	O395001		18	20
4	Manille	O901031	10878	18	20
5	Boulon	O393003		18	20
6	Couteau	O901049		36	40

TIL100 Double chappe

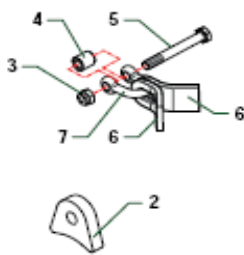

N°	Designation	Référence	Réf SCAR	TIL100
2	Chappe	TN12020601		36
3	Ecrou	O359003		18
4	Bague	1101088		18
5	Boulon	O393006	10880	18
6	Couteau	O901049		36
7	Manille	O901137		18

TIM110

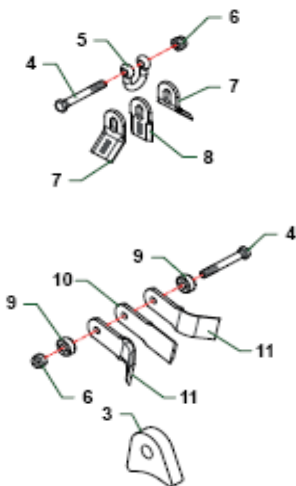

N°	Designation	Référence	Réf SCAR	TIM110
3	Chappe	TN12020601		32
4	Boulon	O393006	10880	16
5	Manille	O901137		16
6	Ecrou	O359003		16
7	Couteau	O901160	10858	32
8	Couteau	O901161	11199	16
9	Bague	1101042	12887	32
10	Couteau	O901159	11198	16
11	Couteau	O901158	11197	32

TIP et TIG100/120 Double chappe selon série

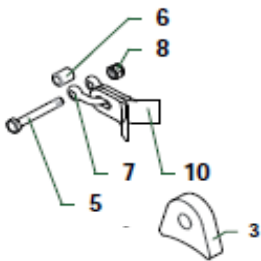

N°	Designation	Référence	Réf SCAR	TIG100	TIG120
3	Chappe	TN12020601		40	48
5	Boulon	O393006	10880	20	24
6	Bague	1101088	16323	20	24
7	Manille	O901137		20	24
8	Ecrou	O359003		20	24
10	Couteau	O901049	10855	40	48

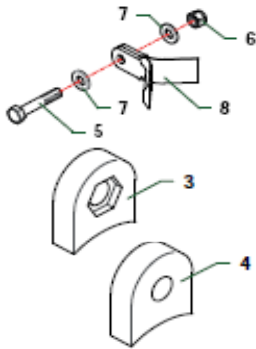

N°	Designation	Référence	Réf SCAR	TIG100	TIG120
3	Chappe	TIP12020201		14	18
4	Chappe	TIP12020202		14	18
5	Boulon	TIP12190100		14	18
6	Ecrou	O310004		14	18
7	Rondelle	1101010		28	36
8	Couteau	O901146		28	36

TJ 125

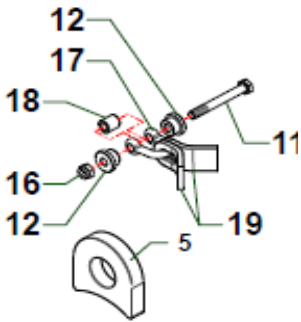

N°	Designation	Référence	Réf SCAR	TJ 26 P
5	Chappe	TJ12021001		52
11	Boulon	0303017		26
12	Bague	1101056		52
16	Ecrou	0359003		26
17	Manille	0901137	10879	26
18	Bague	1101088	16323	26
19	Couteau	0901049		52

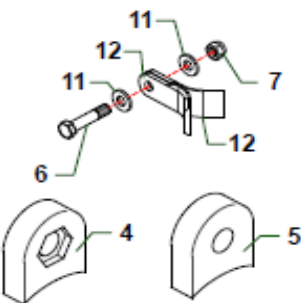

N°	Designation	Référence	Réf SCAR	TJ 20 P
4	Chappe	TIP12020202		20
5	Chappe	TIP12020201		20
6	Boulon	TIP12190100		20
7	Ecrou	0359005		20
11	Rondelle	1101010		40
12	Couteau	0901146	10882	40

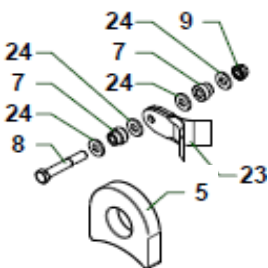

N°	Designation	Référence	Réf SCAR	TJ 26 P
5	Chappe	TJ12021001		52
7	Bague	1101055		52
8	Boulon	035A017		26
9	Ecrou	0359005		26
23	Couteau	0901146		52
24	Rondelle	1101010		104

TN120 Série 2 et 3

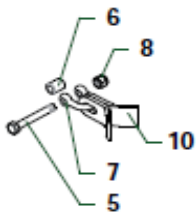

N°	Designation	Référence	Réf SCAR	TN120
5	Boulon	O393006	10880	24
6	Bague	1101088	16323	24
7	Manille	O901137		24
8	Ecrou	O359003		24
10	Couteau	O901068		48

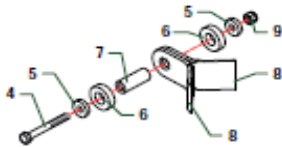

N°	Designation	Référence	Réf SCAR	TN120
4	Boulon	O303017		18
5	Rondelle	1101017		36
6	Bague	1101019		36
7	Bague	1101016		18
8	Couteau	O901003		36
9	Ecrou	O310003		18

TN120 Série 4 et 5

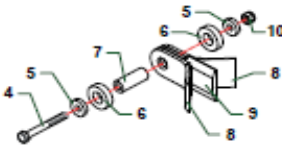

N°	Designation	Référence	Réf SCAR	TN120
4	Boulon	O303017		18
5	Rondelle	1101017		36
6	Bague	1101034		36
7	Bague	1101016		18
8	Couteau	O901003		36
9	Couteaux	0901148		18
10	Ecrous	O310003		18

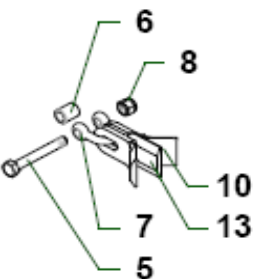

N°	Designation	Référence	Réf SCAR	TN120
5	Boulon	O393006	10880	24
6	Entretoise	1101088		24
7	Manille	O901137		24
8	Ecrou	O359003		24
10	Couteau	O901068		48
13	Couteau	O901153		24

TNP125

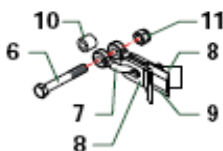

N°	Designation	Référence	Réf SCAR	TNP125
6	Boulon	O393009	12892	30
7	Manille	O901151	12893	30
8	Couteau	O901068		60
9	Couteau	O901153	12894	30
10	Entretoise	1101089		30
11	Ecrou	O359004		30

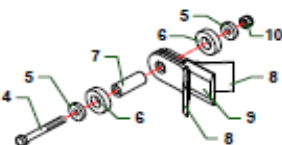

N°	Designation	Référence	Réf SCAR	TNP125
4	Boulon	0901205	12891	22
5	Rondelle	1101017		44
6	Bague	1101034		44
7	Bague	1101016		22
8	Couteau	O901003		44

TNSC 125

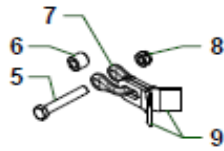

N°	Designation	Référence	Réf SCAR	TNSC125
5	Boulon	TNS125020502	12890	30
6	Entretoise	1101089	12888	30
7	Manille	0901174		30
8	Ecrou	0359004	17014	30
9	Couteau	0901068	10856	60

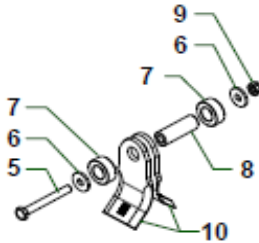

N°	Designation	Référence	Réf SCAR	TNSC125
4	Chappe	TNS125020503		52
5	Boulon	0303017		26
6	Rondelle	1101082		52
7	Bague	1101057		52
8	Bague	1101070		26
9	Ecrou	0359003	10881	26
10	Couteau	0901181		52